



TRANE®

Downflow/Horizontal Right or Left 2-Stage Variable Speed Gas-Fired Furnace

XV 80

**TDD2B060,080,
C100,D120A9V**

**Two-Stage Fan Assisted
Combustion System**

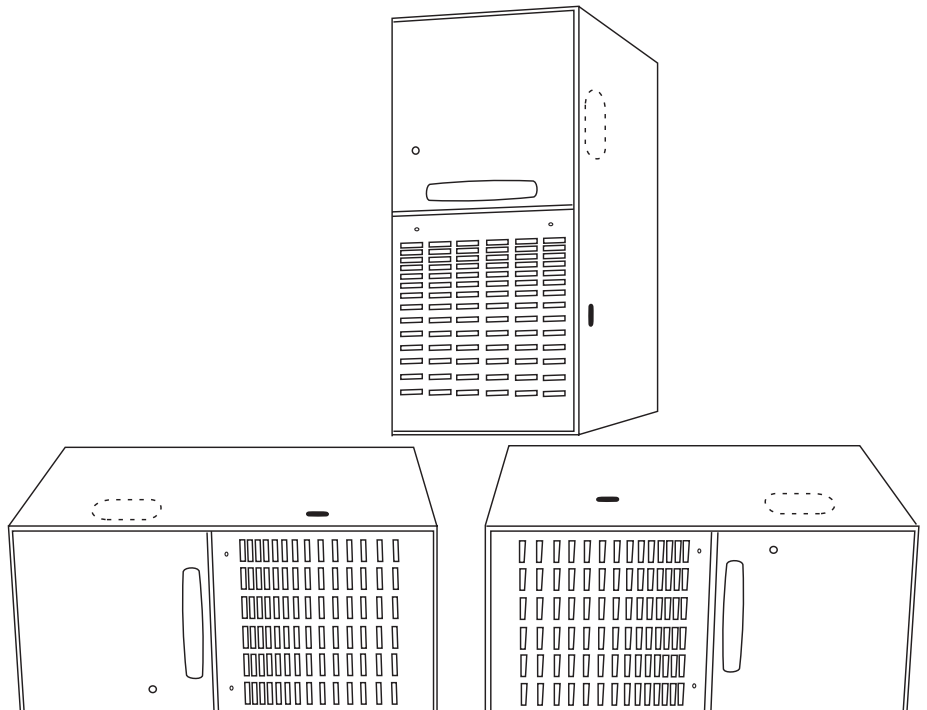

PUB. NO. 22-1673-10



General Features

NATURAL GAS MODELS

Central Heating furnace designs are certified by the American Gas Association for both natural and L.P. gas. Limit setting and rating data were established and approved under standard rating conditions using American National Standards Institute standards.

SAFE OPERATION

The Integrated System Control has solid state devices, which continuously monitor for presence of flame, when the system is in the heating mode of operation. Dual solenoid combination gas valve and regulator provide extra safety.

QUICK HEATING

Durable, cycle tested, heavy gauge aluminized steel heat exchanger quickly transfers heat to provide warm conditioned air to the structure.

BURNERS

Multiport Inshot burners will give years of quiet and efficient service. All models can be converted to L.P. gas.

INTEGRATED SYSTEM CONTROL

Exclusively designed operational program provides total control of furnace limit sensors, blowers, gas valve, flame control and includes self diagnostics for ease of service. Also contains connection points for E.A.C./humidifier.

AIR DELIVERY

The variable speed, direct drive blower motor, has sufficient airflow for most heating and cooling requirements, will switch from heating to cooling speeds on demand from room thermostat. The blower door safety switch will prevent or terminate furnace operation when the blower door is removed.

STYLING

Heavy gauge steel and "wrap-around" cabinet construction is used in the cabinet with baked-on enamel finish for strength and beauty. The heat exchanger section of the cabinet is completely lined with foil faced fiberglass insulation. This results in quiet and efficient operation due to the excellent acoustical and insulating qualities of fiberglass.

FEATURES AND GENERAL OPERATION

The XV 80 High Efficiency Gas Furnaces employs an adaptive Hot Surface Ignition system, which eliminates the waste of a constant burning pilot. The integrated system control lights the main burners upon a demand for heat from the room thermostat. Complete front service access.

- a. Low energy power venter
- b. Vent proving pressure switch.

Contents

General Features	2
Features and Benefits	4
XV 80 STANDARD EQUIPMENT	4
XV 80 OPTIONAL EQUIPMENT	5
General Data	6
Performance Data	7
Electrical Data	11
Field Wiring	13
Dimensions	16



Features and Benefits

XV 80 STANDARD EQUIPMENT DOWNFLOW/HORIZONTAL RIGHT or LEFT

- Convertible to horizontal
- Power supply 115/1/60
- 2-stage gas valve
- 2-speed venter
- Hot surface igniter
- Integrated system control
- Attractive color accents
- Heavy gauge aluminized steel heat exchanger
- Soft start - gradually cycles on airflow
- Direct drive variable speed motor
- Blower door safety switch
- Multiport Inshot burners
- Complete front service access
- Molded plastic nameplate
- Comfort-R™
- Slide out blower assembly
- Adjustable fan off times
- Common vent capability
- Cleanable high velocity filters
- Heavy gauge reinforced wrap-around steel cabinet
- Super quiet performance
- Optional L.P. conversion kit
- Left/right gas connection

Optional Equipment

XV 80 OPTIONAL EQUIPMENT

Thermostat, Mechanical 2-Stage Heating/1-Stage Cooling	TAYSTAT241 []
Thermostat, Heating/Cooling Single Stage (Mounts Horizontally)	AY28X092 []
Thermostat, Heating/Cooling Single Stage (Mounts Vertically)	BAYSTAT305 []
Thermostat, Electronic Programmable 2-Stage Heating/2-Stage Cooling	TAYSTAT302C []
Thermostat, Electronic Programmable 1-Stage Heating/1-Stage Cooling	TAYSTAT300C []
Thermostat, Electronic 1Htg/1Clg (Non-Prog).....	TAYSTAT370 []
Thermostat, Electronic 1Htg/1Clg (Prog-5/2)	TAYSTAT340 []
Propane Conversion Kit	BAYLPKT210A []
Electronic Air Filter, "Perfect Fit" High Efficiency (17-1/2" Wide Gas Furnace).....	TFM175A9FR0 []
Electronic Air Filter, "Perfect Fit" High Efficiency (21" Wide Gas Furnace).....	TFM210A9FR0 []
Electronic Air Filter, "Perfect Fit" High Efficiency (24-1/2" Wide Gas Furnace).....	TFM245A9FR0 []
Electronic Air Filter, "Perfect Fit" Standard Efficiency (17-1/2" Wide Gas Furnace).....	TFP175A9FR0 []
Electronic Air Filter, "Perfect Fit" Standard Efficiency (21" Wide Gas Furnace).....	TFP210A9FR0 []
Electronic Air Filter, "Perfect Fit" Standard Efficiency (24-1/2" Wide Gas Furnace).....	TFP245A9FR0 []
Coil Enclosure (17-1/2" Wide Cabinets)	BAYCLE17A1722A []
Coil Enclosure (21" Wide Cabinets)	BAYCLE21A2130A []
Coil Enclosure (24-1/2" Wide Cabinets)	BAYCLE24A2430A []
Subbase	BAYBASE205 []
Filter Access Door Kit	BAYFLTR206 []
High Altitude Switch.....	BAYHALT249 []
Masonry Chimney Vent Kit	BAYVENT800B []



General Data

Product Specifications ^①

MODEL	TDD2B060A9V3VA	TDD2B080A9V3VA	TDD2C100A9V5VA	TDD2D120A9V5VA
TYPE	Downflow / Horizontal	Downflow / Horizontal	Downflow / Horizontal	Downflow / Horizontal
RATINGS ^②				
1st Stage Input BTUH	39,000	52,000	65,000	78,000
1st Stage Capacity BTUH (ICS) ^③	31,200	41,600	52,000	62,400
2nd Stage Input BTUH	60,000	80,000	100,000	120,000
2nd Stage Capacity BTUH (ICS) ^③	48,000	63,000	81,000	95,000
AFUE (ICS)	80.0	80.0	80.0	80.0
Temp. rise (Min.-Max.) °F.	35 - 65	35 - 65	35 - 65	35 - 65
BLOWER DRIVE	Direct	Direct	Direct	Direct
Diameter - Width (In.)	10 x 7	10 x 7	11 x 10	11 x 10
No. Used	1	1	1	1
Speeds (No.)	Variable	Variable	Variable	Variable
CFM vs. in. w.g.	See Airflow Table	See Airflow Table	See Airflow Table	See Airflow Table
Motor HP	1/2	1/2	1	1
R.P.M.	Variable	Variable	Variable	Variable
Volts/Ph/Hz	115/1/60	115/1/60	115/1/60	115/1/60
FLA	7.7	7.7	12.8	12.8
COMBUSTION FAN — Type	Centrifugal	Centrifugal	Centrifugal	Centrifugal
Drive - No. Speeds	Direct - 2	Direct - 2	Direct - 2	Direct - 2
Motor HP PSC [Shaded Pole] - RPM	1/100 / [1/145] - 2543/1727	1/100 / [1/145] - 2543/1727	1/75 / [1/145] - 2708/1868	1/60 / [1/85] - 3090/2225
Volts/Ph/Hz	115/1/60	115/1/60	115/1/60	115/1/60
FLA PSC [Shaded pole]	0.70/0.40 / [0.23/0.20]	0.70/0.40 / [0.23/0.20]	0.87/0.49 / [0.22/0.20]	1.14/0.51 / [0.25/0.21]
FILTER — Furnished?	Yes	Yes	Yes	Yes
Type Recommended	High Velocity	High Velocity	High Velocity	High Velocity
Hi Vel. (No.-Size-Thk.)	2 - 14x20 - 1in.	2 - 14x20 - 1in.	2 - 16x20 - 1in.	2 - 16x20 - 1in.
VENT — Size (In.)	4 Round	4 Round	4 Round	4 Round
HEAT EXCHANGER				
Type -Fired	Alum. Steel - Type 1	Alum. Steel - Type 1	Alum. Steel	Alum. Steel
-Unfired				
Gauge (Fired)	20	20	20	20
ORIFICES — Main				
Nat. Gas. Qty. — Drill Size	3 — 45	4 — 45	5 — 45	6 — 45
L.P. Gas Qty. — Drill Size	3 — 56	4 — 56	5 — 56	6 — 56
GAS VALVE	Redundant - Two Stage	Redundant - Two Stage	Redundant - Two Stage	Redundant - Two Stage
PILOT SAFETY DEVICE				
Type	Hot Surface Ignition	Hot Surface Ignition	Hot Surface Ignition	Hot Surface Ignition
BURNERS — Type	Multi-port In-shot	Multi-port In-shot	Multi-port In-shot	Multi-port In-shot
Number	3	4	5	6
POWER CONN. — V/Ph/Hz ^④	115/1/60	115/1/60	115/1/60	115/1/60
Ampacity (In Amps)	10.5	10.5	14.9	15.3
Max. Overcurrent Protection (Amps)	15	15	20	20
PIPE CONN. SIZE (In.)	1/2	1/2	1/2	1/2
DIMENSIONS	H x W x D	H x W x D	H x W x D	H x W x D
Crated (In.)	41-3/4 x 19-1/2 x 30-1/2	41-3/4 x 19-1/2 x 30-1/2	41-3/4 x 23 x 30-1/2	41-3/4 x 26-1/2 x 30-1/2
WEIGHT				
Shipping (Lbs.)/Net (Lbs.)	140 / 129	146 / 135	166 / 155	197 / 185

① Central Furnace heating designs are certified to ANSI Z21.47 / CSA 2.3.

② For U.S. applications, above input ratings (BTUH) are up to 2,000 feet, derate 4% per 1,000 feet for elevations above 2,000 feet above sea level. For Canadian applications, above input ratings (BTUH) are up to 4,500 feet, derate 4% per 1,000 feet for elevations above 4,500 feet above sea level.

③ Based on U.S. government standard tests.

④ The above wiring specifications are in accordance with National Electrical Code; however, installations must comply with local codes.

Performance Data

*DD2B060A9V3VA FURNACE HEATING AIRFLOW (CFM) AND POWER (WATTS) VS. EXTERNAL STATIC PRESSURE WITH FILTER									
	AIRFLOW SETTING	DIP SWITCH SETTING			EXTERNAL STATIC PRESSURE				
		S4-3	S4-4		0.1	0.3	0.5	0.7	0.9
HEATING 1ST STAGE	LOW	ON	ON	CFM TEMP. RISE WATTS	547 53 48	593 49 80	571 51 107	567 51 143	544 53 170
	MEDIUM **	ON	OFF	CFM TEMP. RISE WATTS	658 44 65	664 44 92	658 44 122	658 44 155	652 44 197
	HIGH	OFF	OFF	CFM TEMP. RISE WATTS	735 39 75	761 38 120	761 38 155	764 38 190	762 38 230
HEATING 2ND STAGE	LOW	ON	ON	CFM TEMP. RISE WATTS	743 60 75	777 57 120	775 57 155	783 57 195	772 58 230
	MEDIUM **	ON	OFF	CFM TEMP. RISE WATTS	874 51 105	887 50 150	881 50 185	894 50 230	894 50 270
	HIGH	OFF	OFF	CFM TEMP. RISE WATTS	996 45 143	1013 44 192	1041 43 250	1058 42 307	1069 42 337

*DD2B060A9V3VA FURNACE COOLING AIRFLOW (CFM) AND POWER (WATTS) VS. EXTERNAL STATIC PRESSURE WITH FILTER											
OUTDOOR UNIT SIZE (TONS)	AIRFLOW SETTING	DIP SWITCH SETTING					EXTERNAL STATIC PRESSURE				
		S3-1	S3-2	S3-3	S3-4		0.1	0.3	0.5	0.7	0.9
1.5	LOW (350 CFM/ TON)	ON	ON	OFF	ON	CFM WATTS	533 45	563 75	546 100	534 130	515 160
	NORMAL (400 CFM/ TON)	ON	ON	OFF	OFF	CFM WATTS	609 55	627 90	624 115	606 150	607 180
	HIGH (450 CFM/ TON)	ON	ON	ON	OFF	CFM WATTS	664 65	683 95	690 135	687 165	680 200
2.0	LOW (350 CFM/ TON)	OFF	ON	OFF	ON	CFM WATTS	693 65	714 105	708 135	706 170	712 210
	NORMAL (400 CFM/ TON)	OFF	ON	OFF	OFF	CFM WATTS	780 85	821 130	813 165	810 205	816 245
	HIGH (450 CFM/ TON)	OFF	ON	ON	OFF	CFM WATTS	886 110	896 150	901 200	925 250	930 285
2.5	LOW (350 CFM/ TON)	ON	OFF	OFF	ON	CFM WATTS	865 105	882 145	869 185	884 275	885 265
	NORMAL (400 CFM/ TON)	ON	OFF	OFF	OFF	CFM WATTS	977 135	983 180	1014 235	1035 290	1019 330
	HIGH (450 CFM/ TON)	ON	OFF	ON	OFF	CFM WATTS	1097 170	1125 235	1155 305	1169 350	1169 405
3.0 **	LOW (350 CFM/ TON)	OFF	OFF	OFF	ON	CFM WATTS	1006 145	1034 200	1056 255	1072 315	1067 352
	NORMAL ** (400 CFM/ TON)	OFF	OFF	OFF	OFF	CFM WATTS	1169 215	1202 265	1226 355	1221 390	1217 440
	HIGH (450 CFM/ TON)	OFF	OFF	ON	OFF	CFM WATTS	1313 290	1339 370	1360 425	1369 500	1357 525

NOTES:

1. *FIRST LETTER MAY BE "A" OR "T"
2. **FACTORY SETTING.
3. CONTINUOUS FAN SETTING: HEATING OR COOLING AIRFLOW IS APPROXIMATELY 50% OF SELECTED COOLING VALUE.
4. LOW 350 CFM/TON IS RECOMMENDED FOR VARIABLE SPEED APPLICATION FOR COMFORT & HUMID CLIMATE SETTING: NORMAL IS 400 CFM/TON: HIGH 450 CFM/TON IS FOR DRY CLIMATE SETTING.



Performance Data

*DD2B080A9V3VA FURNACE HEATING AIRFLOW (CFM) AND POWER (WATTS) VS. EXTERNAL STATIC PRESSURE WITH FILTER									
	AIRFLOW SETTING	DIP SWITCH SETTING			EXTERNAL STATIC PRESSURE				
		S4-3	S4-4		0.1	0.3	0.5	0.7	0.9
HEATING 1ST STAGE	LOW	ON	ON	CFM TEMP. RISE WATTS	775 50 85	750 51 110	700 55 140	685 56 170	680 57 185
	MEDIUM **	ON	OFF	CFM TEMP. RISE WATTS	865 45 110	840 46 140	820 47 175	795 48 210	770 50 235
	HIGH	OFF	OFF	CFM TEMP. RISE WATTS	1010 38 160	980 39 190	970 40 230	940 41 260	915 42 285
HEATING 2ND STAGE	LOW	ON	ON	CFM TEMP. RISE WATTS	1080 55 180	1060 56 220	1035 57 255	1010 59 285	995 60 325
	MEDIUM **	ON	OFF	CFM TEMP. RISE WATTS	1190 50 245	1190 50 290	1170 51 330	1155 51 370	1140 52 410
	HIGH	OFF	OFF	CFM TEMP. RISE WATTS	1345 44 330	1335 44 380	1320 45 425	1310 45 475	1275 46 505

*DD2B080A9V3VA FURNACE COOLING AIRFLOW (CFM) AND POWER (WATTS) VS. EXTERNAL STATIC PRESSURE WITH FILTER											
OUTDOOR UNIT SIZE (TONS)	AIRFLOW SETTING	DIP SWITCH SETTING					EXTERNAL STATIC PRESSURE				
		S3-1	S3-2	S3-3	S3-4		0.1	0.3	0.5	0.7	0.9
2.5	LOW (350 CFM/TON)	OFF	ON	OFF	ON	CFM WATTS	840 105	830 135	830 160	815 220	750 225
	NORMAL (400 CFM/TON)	OFF	ON	OFF	OFF	CFM WATTS	970 140	950 170	940 210	925 245	900 270
	HIGH (450 CFM/TON)	OFF	ON	ON	OFF	CFM WATTS	1085 185	1060 220	1045 260	1015 300	1000 325
3.0	LOW (350 CFM/TON)	ON	OFF	OFF	ON	CFM WATTS	1015 155	995 190	990 230	970 260	920 285
	NORMAL (400 CFM/TON)	ON	OFF	OFF	OFF	CFM WATTS	1150 215	1140 250	1120 305	1100 335	1085 370
	HIGH (450 CFM/TON)	ON	OFF	ON	OFF	CFM WATTS	1290 300	1290 340	1270 390	1260 425	1235 475
3.5 **	LOW (350 CFM/TON)	OFF	OFF	OFF	ON	CFM WATTS	1160 220	1150 265	1140 320	1115 345	1100 385
	NORMAL ** (400 CFM/TON)	OFF	OFF	OFF	OFF	CFM WATTS	1355 330	1340 380	1330 425	1320 470	1280 510
	HIGH (450 CFM/TON)	OFF	OFF	ON	OFF	CFM WATTS	1360 330	1360 380	1315 425	1320 470	1280 510

NOTES:

- * First letter may be "A" or "T"
- ** Factory setting
- Continuous Fan Setting: Heating or Cooling airflow is approximately 50% of selected Cooling value.
- LOW 350 cfm/ton is recommended for Variable Speed application for COMFORT & HUMID CLIMATE setting; NORMAL is 400 cfm/ton; HIGH 450 cfm/ton is for DRY CLIMATE setting

Performance Data

*DD2C100A9V5VA FURNACE HEATING AIRFLOW (CFM) AND POWER (WATTS) VS. EXTERNAL STATIC PRESSURE WITH FILTER									
	AIRFLOW SETTING	DIP SWITCH SETTING			EXTERNAL STATIC PRESSURE				
		S4-3	S4-4		0.1	0.3	0.5	0.7	0.9
HEATING 1ST STAGE	LOW	ON	ON	CFM TEMP. RISE WATTS	890 54 87	870 55 120	855 56 160	850 57 200	825 58 250
	MEDIUM **	ON	OFF	CFM TEMP. RISE WATTS	1100 44 135	1090 44 175	1080 45 225	1070 45 260	1070 45 320
	HIGH	OFF	OFF	CFM TEMP. RISE WATTS	1270 38 195	1290 37 260	1295 37 315	1300 37 365	1300 37 425
HEATING 2ND STAGE	LOW	ON	ON	CFM TEMP. RISE WATTS	1230 60 180	1220 61 220	1250 59 290	1255 59 345	1275 58 410
	MEDIUM **	ON	OFF	CFM TEMP. RISE WATTS	1520 49 295	1550 48 385	1560 47 460	1555 48 525	1530 48 565
	HIGH	OFF	OFF	CFM TEMP. RISE WATTS	1820 41 475	1825 41 570	1825 41 625	1800 41 685	1740 43 695

*DD2C100A9V5VA FURNACE COOLING AIRFLOW (CFM) AND POWER (WATTS) VS. EXTERNAL STATIC PRESSURE WITH FILTER											
OUTDOOR UNIT SIZE (TONS)	AIRFLOW SETTING	DIP SWITCH SETTING					EXTERNAL STATIC PRESSURE				
		S3-1	S3-2	S3-3	S3-4		0.1	0.3	0.5	0.7	0.9
3.0	LOW (350 CFM/TON)	ON	ON	OFF	ON	CFM WATTS	1025 125	1050 165	1035 195	1030 250	1005 285
	NORMAL (400 CFM/TON)	ON	ON	OFF	OFF	CFM WATTS	1185 165	1180 210	1180 250	1190 315	1190 365
	HIGH (450 CFM/TON)	ON	ON	ON	OFF	CFM WATTS	1300 200	1345 280	1355 325	1375 405	1370 450
3.5	LOW (350 CFM/TON)	OFF	ON	OFF	ON	CFM WATTS	1195 165	1185 215	1200 270	1200 320	1190 370
	NORMAL (400 CFM/TON)	OFF	ON	OFF	OFF	CFM WATTS	1360 230	1390 315	1425 380	1420 430	1420 495
	HIGH (450 CFM/TON)	OFF	ON	ON	OFF	CFM WATTS	1560 320	1595 425	1595 460	1595 540	1570 585
4.0	LOW (350 CFM/TON)	ON	OFF	OFF	ON	CFM WATTS	1350 235	1385 300	1410 375	1420 425	1410 495
	NORMAL (400 CFM/TON)	ON	OFF	OFF	OFF	CFM WATTS	1575 340	1615 420	1625 495	1610 545	1585 595
	HIGH (450 CFM/TON)	ON	OFF	ON	OFF	CFM WATTS	1800 480	1795 555	1790 620	1760 670	1690 675
5.0 **	LOW (350 CFM/TON)	OFF	OFF	OFF	ON	CFM WATTS	1745 440	1760 515	1755 595	1735 640	1670 660
	NORMAL ** (400 CFM/TON)	OFF	OFF	OFF	OFF	CFM WATTS	2010 630	2000 700	1940 745	1865 740	1760 725
	HIGH (450 CFM/TON)	OFF	OFF	ON	OFF	CFM WATTS	2205 830	2130 835	2015 800	1890 760	1740 720

NOTES:

- * First letter may be "A" or "T"
- ** Factory setting
- Continuous Fan Setting: Heating or Cooling airflow is approximately 50% of selected Cooling value.
- LOW 350 cfm/ton is recommended for Variable Speed application for COMFORT & HUMID CLIMATE setting; NORMAL is 400 cfm/ton; HIGH 450 cfm/ton is for DRY CLIMATE setting



Performance Data

DD2D120A9V5VA FURNACE HEATING AIRFLOW (CFM) AND POWER (WATTS) VS. EXTERNAL STATIC PRESSURE WITH FILTER									
	AIRFLOW SETTING	DIP SWITCH SETTING			EXTERNAL STATIC PRESSURE				
		S4-3	S4-4		0.1	0.3	0.5	0.7	0.9
HEATING 1ST STAGE	LOW	ON	ON	CFM TEMP. RISE WATTS	970 60 85	990 58 140	980 59 180	955 61 210	930 62 255
	MEDIUM **	ON	OFF	CFM TEMP. RISE WATTS	1120 52 120	1140 51 170	1115 52 215	1120 52 270	1120 52 315
	HIGH	OFF	OFF	CFM TEMP. RISE WATTS	1240 47 150	1240 47 210	1240 47 250	1240 47 300	1240 47 360
HEATING 2ND STAGE	LOW	ON	ON	CFM TEMP. RISE WATTS	1360 65 190	1380 64 250	1400 63 315	1425 62 400	1430 62 430
	MEDIUM **	ON	OFF	CFM TEMP. RISE WATTS	1570 57 275	1620 55 370	1640 54 440	1650 54 480	1635 54 560
	HIGH	OFF	OFF	CFM TEMP. RISE WATTS	1720 52 360	1735 51 425	1760 51 515	1760 51 585	1760 51 650

DD2D120A9V5VA FURNACE COOLING AIRFLOW (CFM) AND POWER (WATTS) VS. EXTERNAL STATIC PRESSURE WITH FILTER											
OUTDOOR UNIT SIZE (TONS)	AIRFLOW SETTING	DIP SWITCH SETTING					EXTERNAL STATIC PRESSURE				
		S3-1	S3-2	S3-3	S3-4		0.1	0.3	0.5	0.7	0.9
3.5	LOW (350 CFM/TON)	OFF	ON	OFF	ON	CFM WATTS	1200 150	1200 185	1185 235	1210 290	1210 350
	NORMAL (400 CFM/TON)	OFF	ON	OFF	OFF	CFM WATTS	1355 190	1400 265	1420 335	1445 385	1445 440
	HIGH (450 CFM/TON)	OFF	ON	ON	OFF	CFM WATTS	1535 255	1580 345	1600 415	1620 490	1600 530
4.0	LOW (350 CFM/TON)	ON	OFF	OFF	ON	CFM WATTS	1350 190	1370 250	1400 320	1415 385	1420 445
	NORMAL (400 CFM/TON)	ON	OFF	OFF	OFF	CFM WATTS	1570 275	1600 350	1630 425	1640 500	1630 560
	HIGH (450 CFM/TON)	ON	OFF	ON	OFF	CFM WATTS	1800 400	1800 450	1815 540	1820 610	1810 670
5.0 **	LOW (350 CFM/TON)	OFF	OFF	OFF	ON	CFM WATTS	1725 350	1750 440	1770 500	1790 580	1775 650
	NORMAL ** (400 CFM/TON)	OFF	OFF	OFF	OFF	CFM WATTS	1970 515	2015 615	2035 700	2010 775	1960 800
	HIGH (450 CFM/TON)	OFF	OFF	ON	OFF	CFM WATTS	2260 730	2250 830	2215 885	2100 860	1975 810

NOTES:

- * First Letter may be "A" or "T"
- ** Factory setting
- Continuous Fan Setting: Heating or Cooling airflow is approximately 50% of selected Cooling value.
- LOW 350 cfm/ton is recommended for Variable Speed application for COMFORT & HUMID CLIMATE setting; NORMAL is 400 cfm/ton; HIGH 450 cfm/ton is for DRY CLIMATE setting

Electrical Data

WIRING DIAGRAM FOR GAS FURNACES

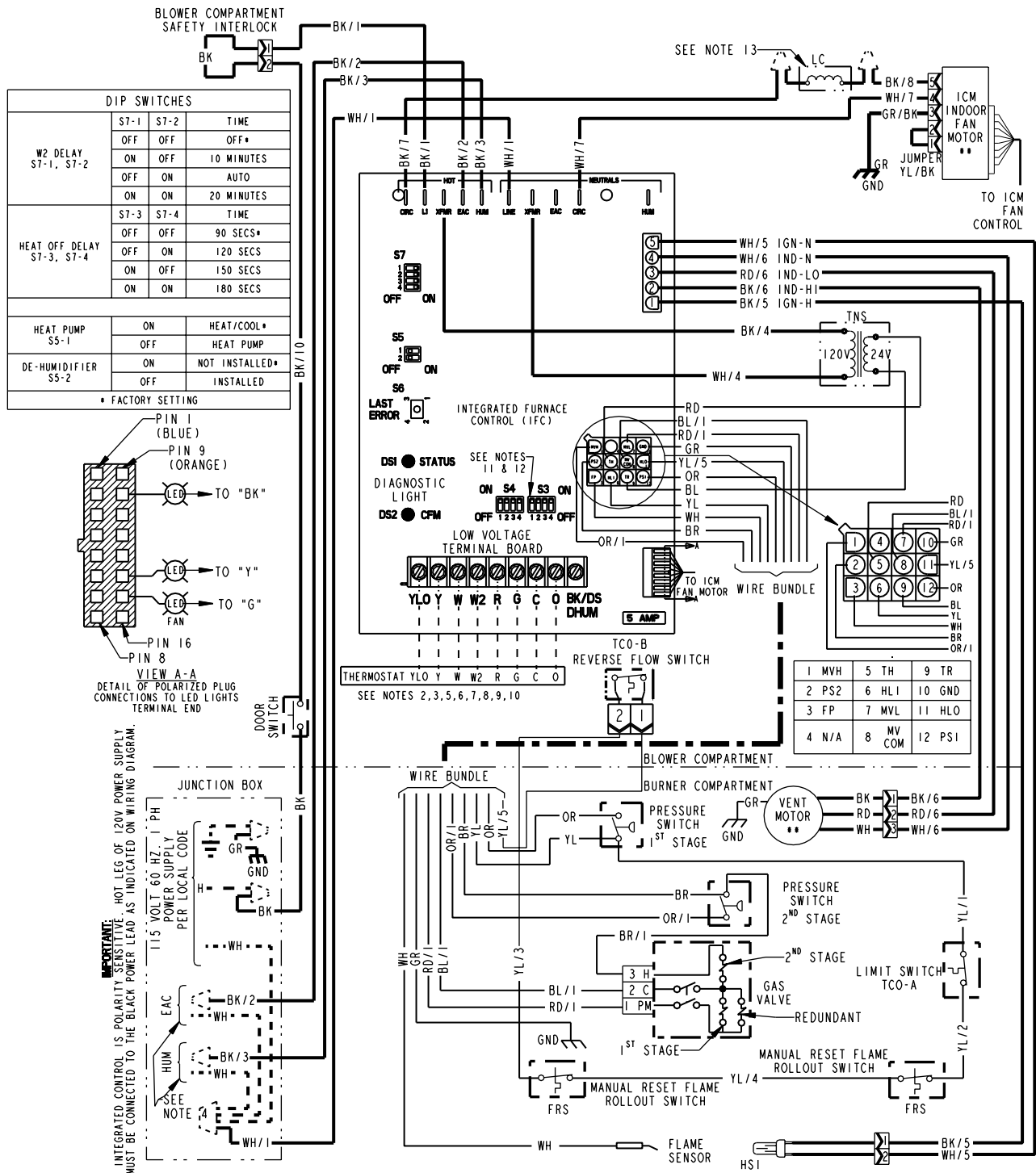

From Dwg. D344300P03

Field Wiring

FIELD WIRING DIAGRAM FOR SINGLE STAGE HEATING ONLY

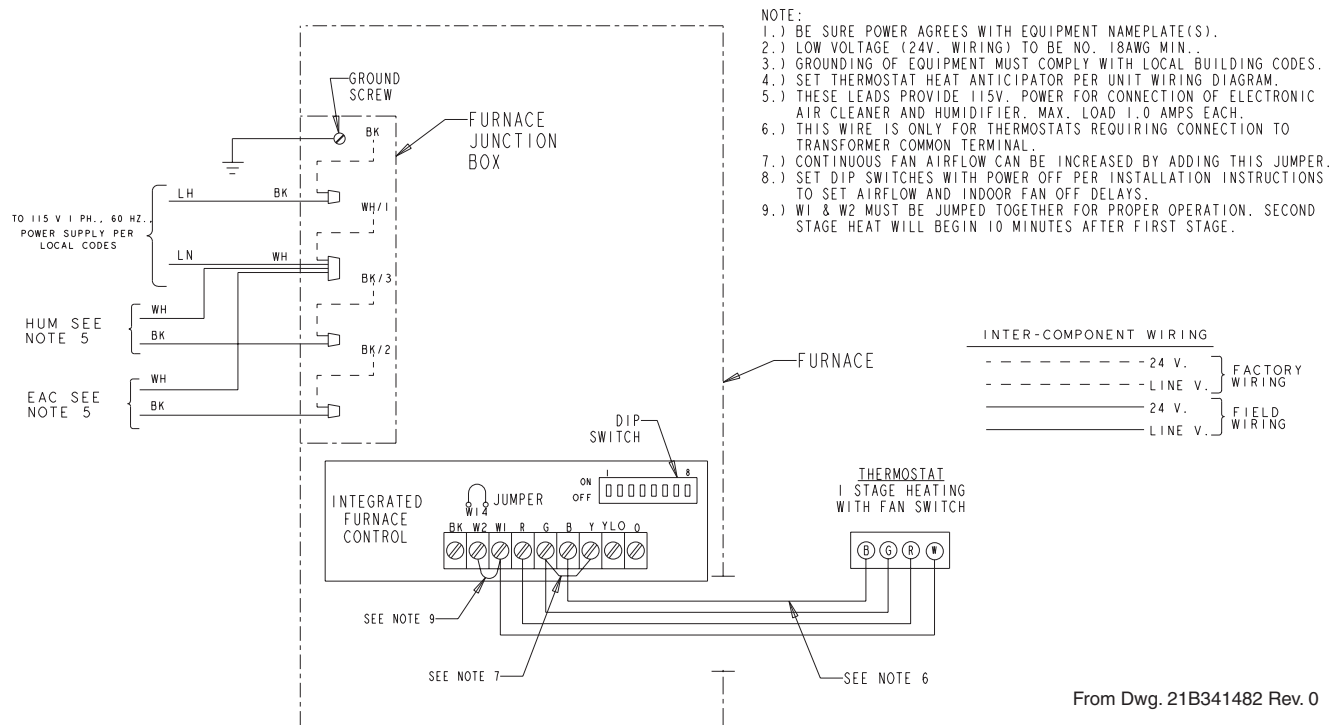

FIELD WIRING DIAGRAM FOR TWO STAGE HEATING

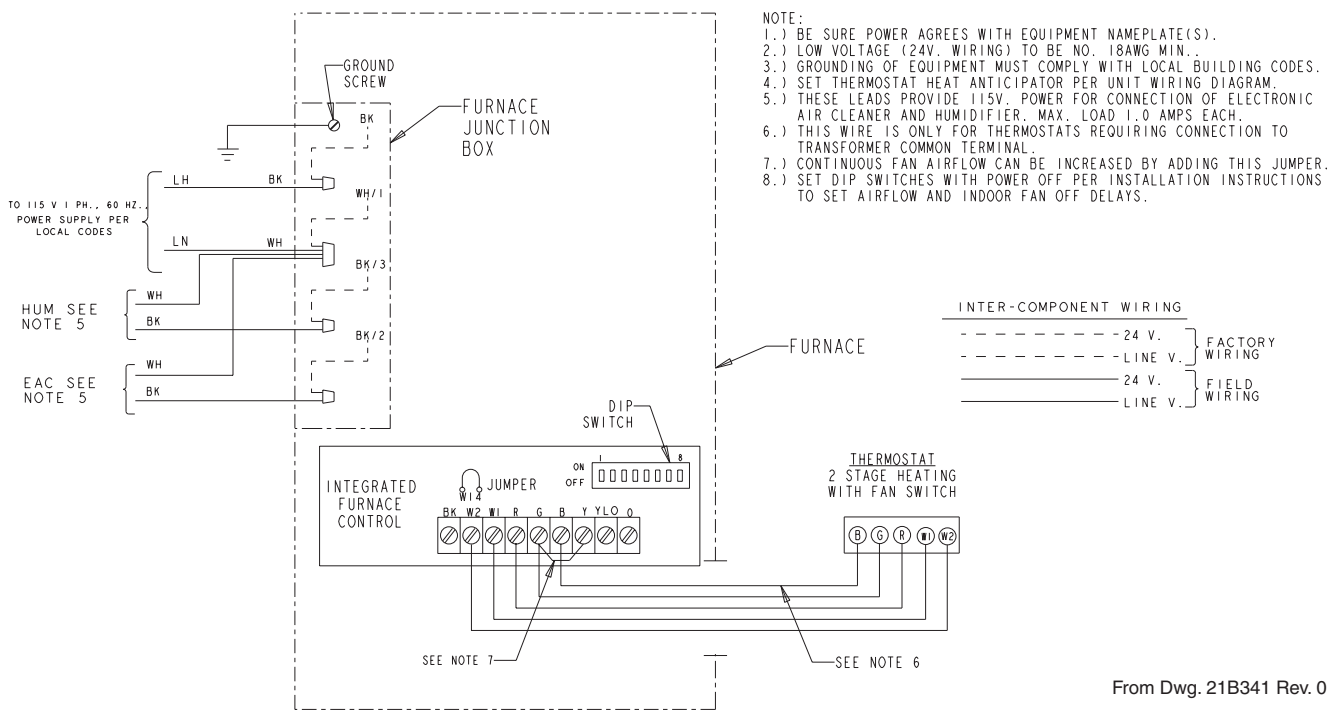

Field Wiring

FIELD WIRING DIAGRAM FOR SINGLE STAGE HEATING WITH SINGLE STAGE COOLING (OUTDOOR SECTION WITHOUT TRANSFORMER)

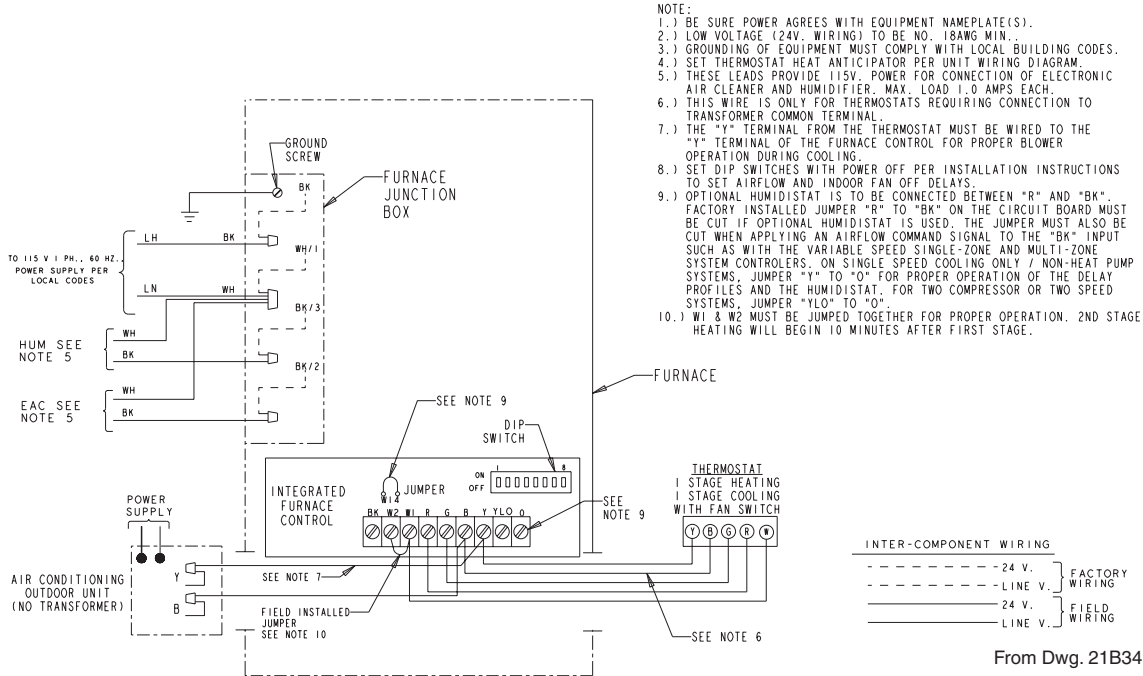

FIELD WIRING DIAGRAM FOR TWO STAGE HEATING WITH SINGLE STAGE COOLING (OUTDOOR SECTION WITHOUT TRANSFORMER)

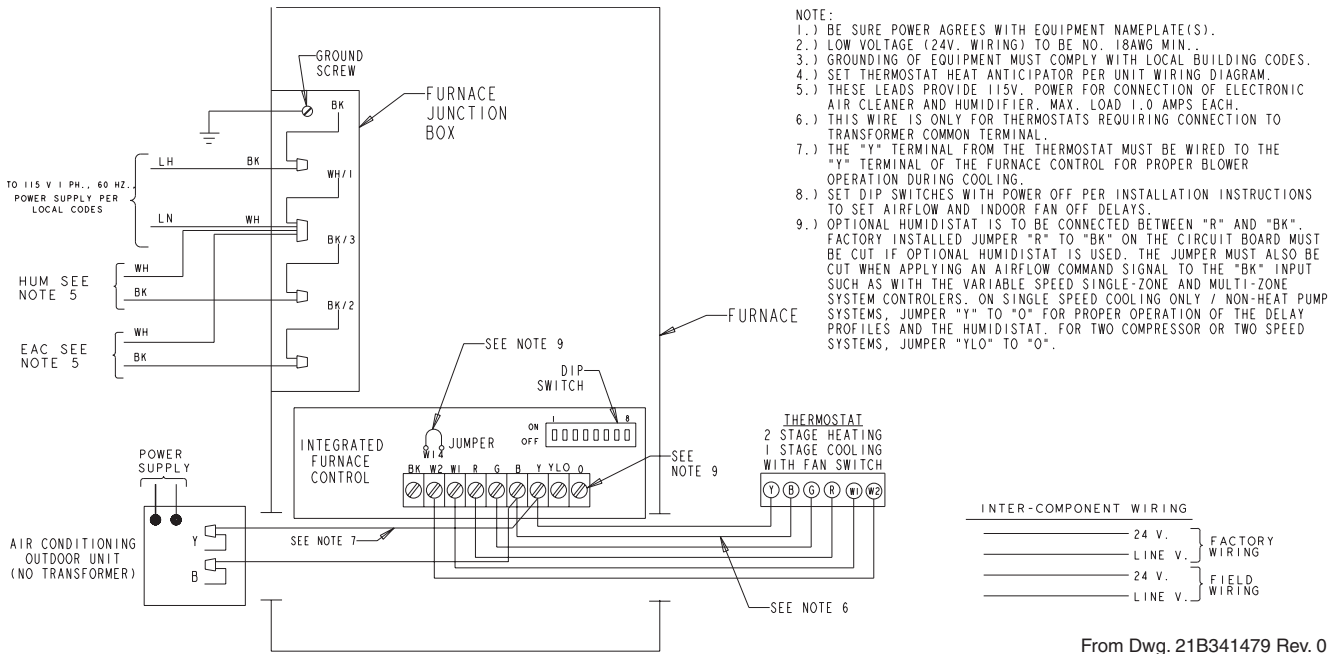

Field Wiring

FIELD WIRING DIAGRAM FOR TWO STAGE HEATING WITH TWO STAGE COOLING (OUTDOOR SECTION WITHOUT TRANSFORMER)

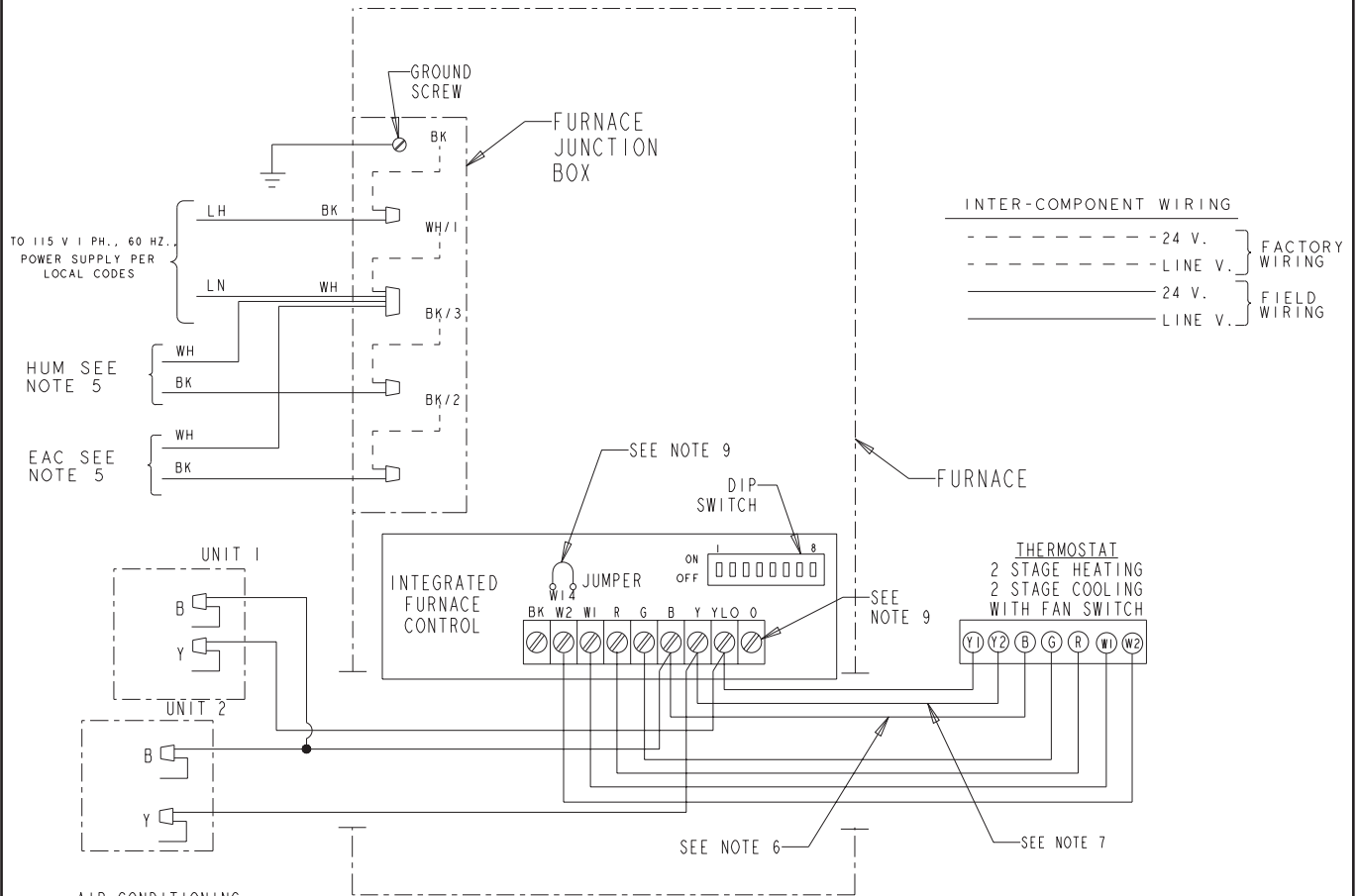

NOTE:

- 1.) BE SURE POWER AGREES WITH EQUIPMENT NAMEPLATE(S).
- 2.) LOW VOLTAGE (24V. WIRING) TO BE NO. 18AWG MIN..
- 3.) GROUNDING OF EQUIPMENT MUST COMPLY WITH LOCAL BUILDING CODES.
- 4.) SET THERMOSTAT HEAT ANTICIPATOR PER UNIT WIRING DIAGRAM.
- 5.) THESE LEADS PROVIDE 115V. POWER FOR CONNECTION OF ELECTRONIC AIR CLEANER AND HUMIDIFIER. MAX. LOAD 1.0 AMPS EACH.
- 6.) THIS WIRE IS ONLY FOR THERMOSTATS REQUIRING CONNECTION TO TRANSFORMER COMMON TERMINAL.
- 7.) THE "Y2" TERMINAL FROM THE THERMOSTAT MUST BE WIRED TO THE "Y" TERMINAL OF THE FURNACE CONTROL FOR PROPER BLOWER OPERATION DURING COOLING.
- 8.) SET DIP SWITCHES WITH POWER OFF PER INSTALLATION INSTRUCTIONS TO SET AIRFLOW AND INDOOR FAN OFF DELAYS.
- 9.) OPTIONAL HUMIDISTAT IS TO BE CONNECTED BETWEEN "R" AND "BK". FACTORY INSTALLED JUMPER "R" TO "BK" ON THE CIRCUIT BOARD MUST BE CUT IF OPTIONAL HUMIDISTAT IS USED. THE JUMPER MUST ALSO BE CUT WHEN APPLYING AN AIRFLOW COMMAND SIGNAL TO THE "BK" INPUT SUCH AS WITH THE VARIABLE SPEED SINGLE-ZONE AND MULTI-ZONE SYSTEM CONTROLLERS. ON SINGLE SPEED COOLING ONLY / NON-HEAT PUMP SYSTEMS, JUMPER "Y" TO "O" FOR PROPER OPERATION OF THE DELAY PROFILES AND THE HUMIDISTAT. FOR TWO COMPRESSOR OR TWO SPEED SYSTEMS, JUMPER "YLO" TO "O".

From Dwg. 21B341490 Rev. 0

Dimensions

*DD2-9V OUTLINE DRAWING (ALL DIMENSIONS ARE IN INCHES)

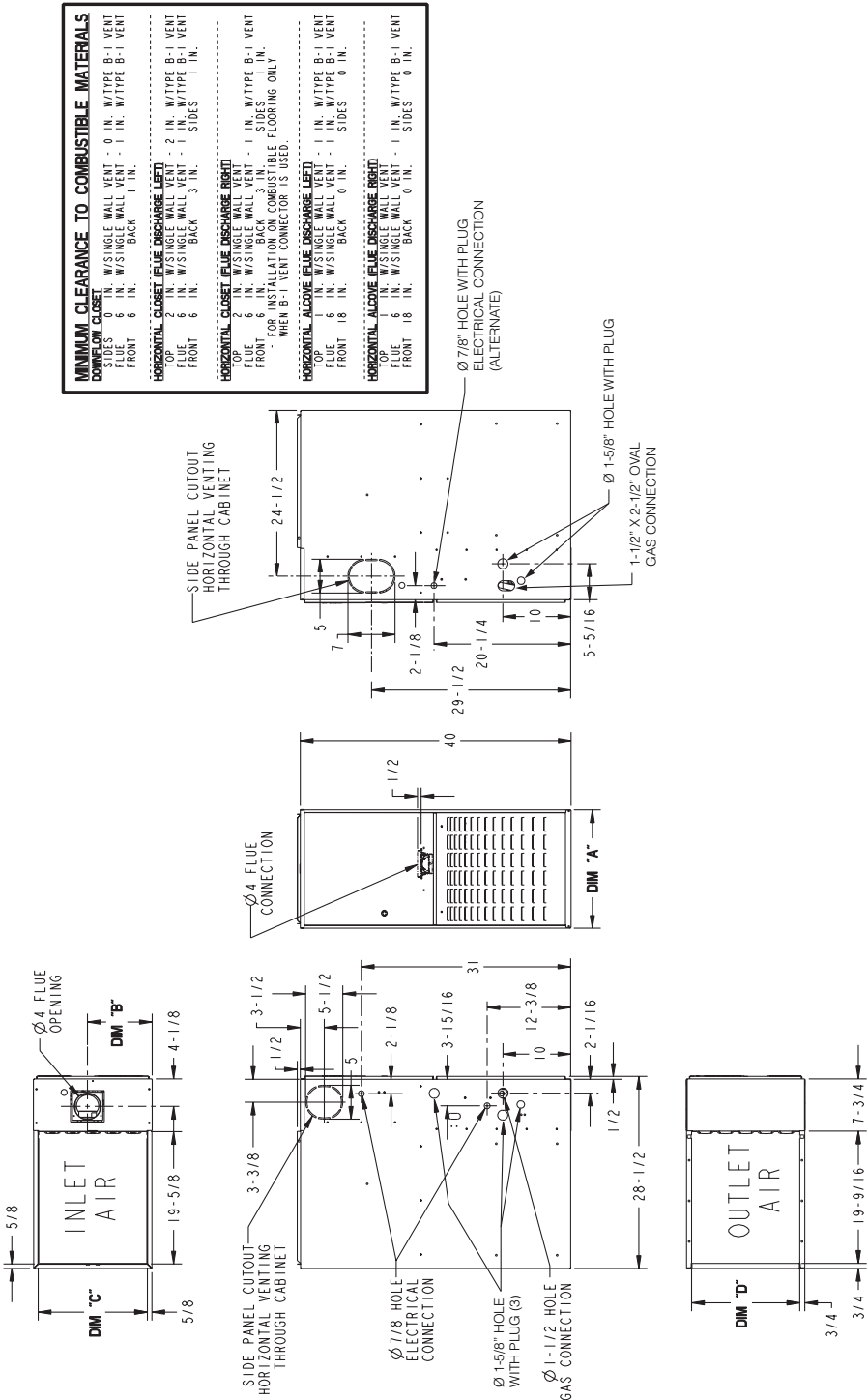

MODEL	DIM "A"	DIM "B"	DIM "C"	DIM "D"
*DD2B060A9V3VA	17-1/2"	9-5/8"	16-1/4"	16"
*DD2B080A9V3VA	21"	13-1/16"	19-3/4"	19-1/2"
*DD2C100A9V5VA	24-1/2"	15-5/16"	23-1/4"	23"

* - The First Letter May Be "A" or "I"